

SFA

222

11.05
IND1-01

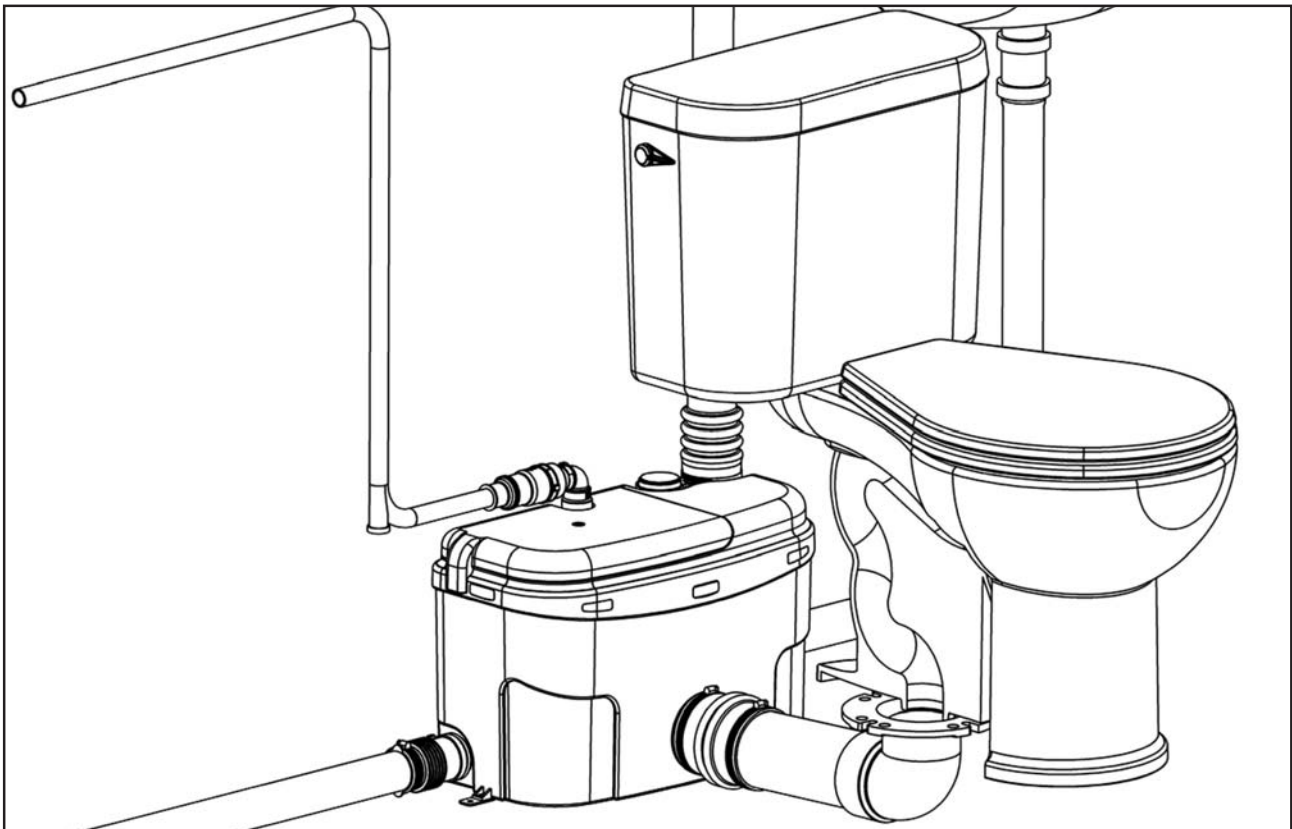

Read carefully before installing Sanigrind; retain this Instruction Book for future reference.
Avant d'installer Sanigrind, lisez attentivement cette brochure et conservez-la en cas de besoin.

**This product must be installed in strict accordance with local plumbing codes.
Product should be installed by a licensed plumber.
Le produit doit être installé dans le respect des règlements sanitaires locaux.
Le produit doit être installé par un plombier qualifié.**



**INSTALLATION AND MAINTENANCE INSTRUCTIONS
INSTRUCTIONS D'INSTALLATION ET D'ENTRETIEN**

*Install a Toilet or Bathroom anywhere you like
Installez une toilette ou une salle de bains partout où vous le désirez.*

SANI GRIND®

SANITARY FOR ALL LTD

Plum' the Impossible

SANIGRIND®

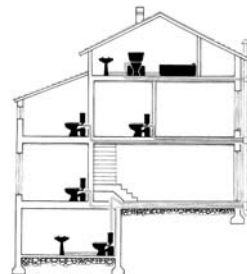

Install a toilet or bathroom anywhere you like

Dear Customer,

Thank you for purchasing a Sanigrind macerating toilet system. We are sure that it will provide you with the luxury of additional bathroom facilities that would otherwise be impractical or too expensive to consider.

Our units have been marketed for many decades throughout Europe and North America and we provide a limited two year warranty on parts and labour of the macerating pump unit. Before commencing with the installation please read carefully the installation instructions.

Enclosed with the product you will find a warranty registration card and a Questionnaire. Please fill out both and return them to us within seven workdays.

Please note that this information is for your own use and will not be sold or otherwise made public.

In the event of a warranty claim, non-registered claimants will have to provide a proof of purchase to verify their warranty claim, thus delaying possibly repairs.

We kindly ask you to fill out the questionnaire; this will greatly assist us in further improving our customer service. Upon receipt of the warranty registration card and questionnaire we will mail you a small gift for your help.

Thank you for your confidence in our products. We are sure they will give you complete satisfaction.

Yours faithfully,

SFA Saniflo Inc.

P.S. In the unfortunate event that a repair is necessary, please contact us first and then contact your installer. There are often cases of delay due to the late forwarding of the customer's complaint.

Madame, Monsieur,

Nous vous remercions d'avoir acheté un cabinet à système de broyage Sanigrind. Nous sommes persuadés qu'il vous donnera le luxe d'un cabinet supplémentaire qu'il serait difficile ou trop coûteux d'acquérir autrement.

Nos cabinets se vendent partout en Europe et en Amérique du Nord, depuis plusieurs décennies, et nous vous offrons une garantie limitée de 2 ans sur les pièces et la main-d'œuvre pour l'ensemble broyeur-pompe. Avant d'installer votre nouveau cabinet, veuillez lire attentivement les instructions d'installation.

Une carte d'enregistrement de la garantie, ainsi qu'un questionnaire, accompagnent le produit. Nous vous prions de les remplir et de nous les retourner dans un délai de sept jours ouvrables. Veuillez prendre note que ces renseignements sont strictement confidentiels et qu'ils ne seront pas vendus ni publiés.

Nous attirons votre attention sur le fait qu'en cas de réclamation aux termes de la garantie, les clients dont la garantie n'a pas été enregistrée doivent fournir une preuve d'achat à l'appui de leur réclamation, ce qui retarde les travaux de réparation.

Nous vous prions de bien vouloir remplir le questionnaire, car cela nous aidera à améliorer davantage notre service à la clientèle. Dès réception de la carte d'enregistrement de la garantie et du questionnaire dûment remplis, nous vous enverrons un petit cadeau par la poste pour vous remercier de votre collaboration.

Nous vous remercions pour la confiance que vous nous avez témoignée en achetant un de nos produits et nous n'avons aucun doute qu'il vous donnera entière satisfaction.

Cordialement,

SFA Saniflo Inc.

P.S. Si malheureusement vous aviez à faire réparer l'appareil, veuillez communiquer avec nous d'abord, et avec votre installateur par la suite. Des retards sont souvent occasionnés à cause du fait que la plainte du client ne nous est pas acheminée à temps.

Introduction

The macerating system can simultaneously receive wastewater from several sanitary fixtures, e.g. bidet, hand basin, shower, bathtub, urinal, but only from one toilet per unit.

Macerating systems are designed for the disposal of human waste, toilet paper, as well as for kitchen, dishwasher or washing machine water.

Sanitary fixtures connected to the macerating system must be located on the same level.

General description

The macerating system is a residential grinder and pumping system for toilet and bathroom fixtures. The macerator pump unit connects to a vertical outlet toilet. The system is comprised of three major components: the macerator unit, the toilet bowl and the toilet tank.

The macerator unit also consists of three major parts: the case which houses the operating mechanism; a pressure chamber which automatically activates and deactivates; the induction motor which drives the grinding blade and the impeller pump (below the motor).

Vent connector (n°1 figure 1)

Air venting by connection to a vent system.

Sanitary inlets

The macerating pump unit is equipped with two 1 1/2" inlets, one on either side of the case. These inlets are used to connect other sanitary fixtures. When installing a bathtub, take into account the necessary slope for drainage by gravity. Since the Sanigrind is generally installed below ground level, gravity-flow should not be a problem.

However, if necessary, you can build a 2 x 8-inch platform, on which the tub can be placed. This gives enough space for a p-trap. Similarly, a special raised shower base can be purchased. Contact SFA Canada for details.

Normal operating cycle

As the toilet is operated or as the bath, shower or hand basin discharges, the water and waste enter the unit. The water level begins to rise, engaging the pressure switch in the pressure chamber. This in turn activates the motor and pump. The shredder blades rotate at 3600 RPM, shredding waste. The shredded waste is picked up by the impeller pump and discharged through a 3/4" outlet pipe to a sanitary sewer or soil stack.

Safety note: For safety reasons the macerating unit should never be activated with the lid removed

Preparing the macerating pump unit (see figure 1 and pages 8, 9)

Push the discharge elbow-flapper in the desired direction for drainage.

At this point you can connect the pipework from the other sanitary fixtures to the macerating system, (see « Connection to discharge pipework & soil stack »).

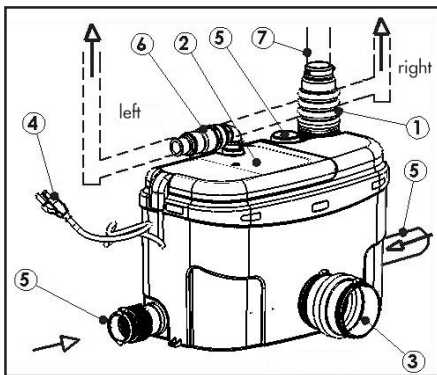

1. Vent connection
2. Removable lid
3. Accordion toilet connector
4. Power supply cable with ground wire
5. RH/LH gravity fed inlets, 1 1/2"
6. Discharge elbow with check valve
7. Vent pipe, 1 1/2"

FIGURE 1

System assembly

(See connection to discharge pipework)

1. Place the macerator at the desired location and connect the pipe work to it (See Connection to Discharge Pipe Work,
2. Rough-in the proprietary flange/elbow as per toilet requirements. I.e. 10' or 12' from the finished wall. Glue a 3" drain pipe into the elbow and insert the other side into the macerator connector.
Note: The Flange/Elbow is made of ABS material, you will be able to use PVC pipe if using an ABS/PVC transition cement,
3. Insert toilet bowl screws into the flange, place wax ring onto the flange and place the bowl on the flange. Slip the china protectors over the toilet bowl screws and tighten. Snap plastic cover caps in place,
4. Install tank as per toilet installation instructions.

Connection to water supply

Connect the water supply hose to the fill valve.

Connection to the discharge pipework

Use rigid wall pipe, copper, PVC or CPVC not flexible pipe or hose.

Option: You can install a “full-port” gate valve and a drain at the lower portion of the discharge pipe, in order to facilitate the removal of the macerating pump unit.

Connection to the soil-stack or sewer

The macerating system will pump up to 18 feet vertically, or up to a maximum of 150 feet horizontally, with a constant 1/4" to 1' gravity fall (minimum) throughout the run to the point of discharge. If you require a vertical lift it should precede any “horizontal” run and should commence as near as possible to the discharge elbow. (Page 15)

The above given vertical and horizontal distances are both maximums: to combine them, please consult the « Performance Chart ».

If you wish the unit to pump vertically and horizontally you can assume that 3 feet of vertical lift is equivalent to 30 feet of “horizontal” run. Each bend or change of direction gives a pressure drop, which must be deducted from the discharge performance figures in accordance with the usual head loss practice. (reduce height by about 1 foot for every bend).

The discharge pipe work can be made of 3/4" copper, CPVC or PVC. The open end of the **flapper** accepts any of these three materials and the gear clamp secures the assembly. Use two 45° pieces back to back to make a 90° elbow.

The connection to the soil-stack or sewer pipe should be made with an approved Y fitting. When in doubt about this procedure, have a plumbing contractor install this for you.

Sewer pipe (copper, cast iron, PVC, ABS)

1. Install an appropriate Y fitting into the sewer pipe, (with a 1 1/2" branch hub).
2. Read point 4 first. Glue a bushing, (spigot x FPT 1 1/2" x 3/4") into the 1 1/2" hub of the Y fitting.
3. Screw male adapter, (MPT x Hub 3/4" sweat) into the sleeve. If discharge piping is copper, buy brass adapter; if CPVC buy CPVC adapter.
4. If piping is copper, solder a length of pipe to the male adapter first, allow to cool then screw assembly into female bushing. When soldering pipe systems together, wind a wet rag around the plastic bushing to keep it cool. Maintain at least a distance of 6" between the plastic and the piece soldered. Use Teflon tape on male thread.
5. When using CPVC material, use CPVC glue to glue the CPVC pipe into the ABS fitting. Do not use ABS glue on CPVC pipes

Connection to electrical supply

All wiring should comply with the applicable electrical code in your area. The macerating system requires a single-phase 120-volt, 15 Amp. supply. When installed in a bathroom, the receptacle should be 40 inches away from a shower or bathtub. Connect only to receptacle protected by a ground fault circuit interrupter. (GFCI)

Warning: electrical hazard – this unit is equipped with a grounded plug – in order to reduce the risk of electrical shock, ensure that the unit is plugged to a grounded electric circuit.

Connection to a vent system

The macerating pump system has been designed to enable you to connect it to a vent system as required by local codes. On the right side of the lid, there is an opening for the vent. Slip the supplied accordion connector over the lip and finish of the 1 1/2" PVC or ABS vent pipe.

Warning: Do not use an air admittance valve (cheater, mechanical vents), which are one-way valves. The air pressure in and outside the macerating pump unit must remain constant.

Activating the unit

1. Prior to activating, ensure that the toilet is free of any material from the installation.
2. Open the shut-off valve and let the tank fill up.
3. Ensure power supply is on.
4. Flush several times, allowing some time in between each flush, and depositing a few sheets of toilet paper into the bowl to check discharge piping. There should be no paper remaining in the bowl after each flush.

Usage

The toilet works as a conventional flushing toilet and needs no maintenance in normal use. However, there is nothing wrong with cleaning out the macerating pump unit once a year. (Be careful not to let water enter the electrical chamber).

The macerating system starts automatically once the toilet is flushed or the bath, shower, hand basin, etc. discharges and ceases operation once the contents have been pumped away.

Cautionary notes:

The macerating system is not designed for the disposal of sanitary napkins, tampons, condoms, disposable diapers or paper towels, **in the regular manner.** It should only be used for human waste, toilet paper, bathroom and kitchen water. Disregarding the above might damage the macerating unit and shall void your warranty.

Do not dispose of acids, solvents, oils, paint, paint strippers, food waste, cotton swabs, plastic bags, or anything that could clog, damage or corrode the unit.

Do not hang bleach blocks or hydrochloride cleaners in the toilet tank. These solutions deteriorate the plastic and neoprene components of the flush, fill valves and macerating system components, which may cause leaks. In the event of a power loss do not use the toilet or any other sanitary fixtures connected to the macerating unit since they will not work until the power is restored.

Whenever the unit is not to be used for long periods of time (vacation, power failure, maintenance, etc.) turn off the water supply to the tank and flush the unit to evacuate the water. No leakage into the bowl should ever be permitted from the tank.

In areas which are prone to freezing, the total system must be properly winterized. This includes the draining of all pipes, the toilet tank and bowl and the macerating tank. To winterize the macerating system, pour a jug of plumbers' anti-freeze into the tank and flush the toilet. This will cause the macerating unit to activate and all remaining water will be replaced by plumber's anti-freeze. No parts or labour are covered by the warranty when a breakdown occurs due to freezing.

Problem solving (consumer) (see also page 10)

The macerating system is very reliable. With normal use, long service is assured. However, in certain cases an incident may occur which you may rectify yourself. Before taking any action check the following points:

1. Plumbing system. Correctness of flush system, water supply turned on.
2. Electrical system. GFCI breaker on. Receptacle on. Fuse okay. Breaker on. Male plug still in receptacle. Check that the thermal overload has not been activated; (wait approximately 20 minutes for unit to reactivate).
3. Ensure that no faucet is leaking.
4. If the macerating pump turns on intermittently without the flush having been activated or water having been discharged, check that water out of the toilet tank is not leaking into the bowl.
5. It is normal for the motor to turn once or twice after completing the discharge cycle when the macerating system has not been in use for some time. This cleans the check valve and ensures a good fit.

INSTRUCTIONS FOR QUALIFIED PROFESSIONALS ONLY (see page 10)

1- Verify: that there is no leakage flowing back into the macerating unit due to incorrect seating of the internal check valve and/or improper installation of the discharge elbow. If the macerating unit is equipped with an external check valve, ensure that the flapper seat is clean and is greased lightly with silicone grease.

2- As the unit is connected to the water and electrical supply, it is important to check that the following actions have been taken before opening the unit:

1. If possible, close off the tank's water supply, flush the tank and close the optional ball or gate valve on the outlet pipe.
2. Unplug the unit.
3. Empty out as much water from the bowl as possible.

3- Access the lid and unscrew it.

You can then access the pressure switch, the condenser, which can be easily replaced, if necessary.

4-Dismantling and removing the motor

1. If you must access the macerating unit, remove the hood screw (3) (Figure 2), followed by the 12 screws from the motor mount (35) (Figure 3) and, with the handle, extricate the motor-pump assembly, and remove the pipe ring from the turbo-jet.

Do not attempt to dismantle the motor assembly itself as its components are "clipped" together. These clips may break off when trying to unclip them. In addition to damaging the clips, the motor seals may be damaged when the lid is removed from the motor case. The motor is filled with dielectric oil, do not remove it or replace with regular oil. Please note that the distributor does not keep seals, rings, or oil in stock.

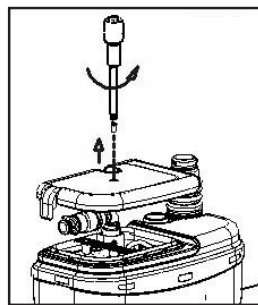

FIGURE 2

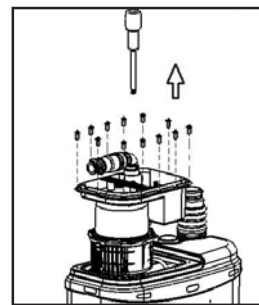

FIGURE 3

Cleaning or changing the grinder blade and the impeller

1. Turn the motor upside down to gain access to the pump body.
2. Unscrew the 3 screws of the grinder blade (fig. 4).
3. Clean or change the grinder blade.
4. Unscrew the pump impeller counter clockwise, releasing it from the spindle.
Clean pump body, discharge elbow and pipework to ensure no blockage exists.
Check that drive shaft rotates freely. Also check that the air relief-hole in the wall of the pump body is clear.
5. Reconnect the grinder blade.
Before reconnecting the grinder blade, ensure that the cross disc 50 is at the far end of the pump. When inserting the motor into the tank, ensure that the elbow end is fully inserted into the tank.

Tip: In order to facilitate the reconnecting of the motor support onto the tank, apply some liquid soap on the rubber joint. Reassemble the unit completely before plugging it back in.

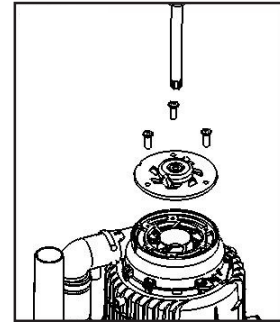

FIGURE 4

Cautionary note

Handle the grinder blade with extreme care; it is extremely sharp. Do not immerse the macerating system in water. Do not let water enter through the electrical cord opening.

Return and repair of the macerating/pump unit

In the event that the unit needs to be returned for service, refer first to the trouble-shooting guide. If these solutions do not work, please call our toll free service number at 1-800-363-5874 for possible further options, or to inquire about an authorized repair shop in your area. When you are required to return the macerating unit to the manufacturer, please ensure that prior to shipping, the unit has been cleaned and disinfected inside and outside. A labour charge of fifty dollars (\$50) will be in effect for cleaning. A prior approval (RGA #) must be obtained from the manufacturer before the unit can be returned.

If you return the macerating unit in its original packaging, please remove the flapper-elbow and the vent connection. If components are not removed, damage may occur during shipping.

Please package the macerating unit properly with adequate shock absorbent material around it.

Send this package prepaid to the manufacturer, making sure to insure against loss and/or transit damage, (the amount of \$300.00 should suffice).

If any repairs are done outside the warranty period, or when the user has damaged the macerating unit, you will receive a repair costs estimate. All repair work will be conducted on a pre-paid basis only.

Pipe Supports

All sanitary pipework must be supported, in accordance with the pipe manufacturer's recommendations to avoid dipping or trapping, which may cause the build up of residual « solids » and subsequent blockage.

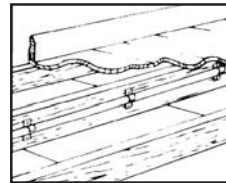

Bends

Where possible pattern bends should be used instead of elbows. If long sweeping 90° elbows are not available, use two 45° elbows to make a 90° turn.

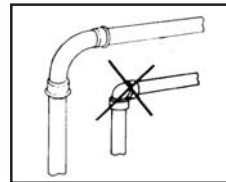

Vertical Installation First

If vertical lift is required, this must precede the horizontal pipe run.

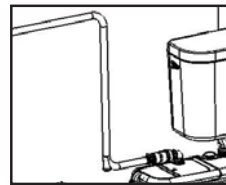

Directly Vertical

All vertical lifts should rise as directly above the unit as possible, allowing only for the need to clear the toilet tank. Any initial horizontal pipe run from the unit, placed prior to a vertical lift, should not exceed 18".

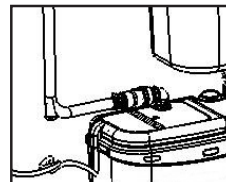

Easy Access

The unit should be accessible and removable in the event of maintenance being required. During the installation a full-port gate or ball valve should be installed at the base of any vertical discharge pipe to allow easy service of the unit.

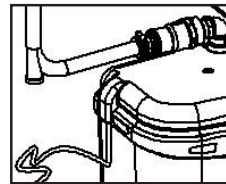

Gravity Fall

The unit accepts wastewater by gravity; it does not pump in water. All pipework must have a positive gravity fall, (1/4" per foot). All horizontal discharge piping from the macerating unit must also have a positive gravity fall to allow free drainage when the pump stops.

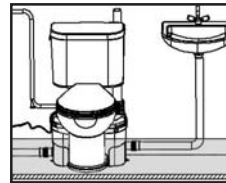

No Direct Fall

Where the point of discharge into the soil stack is significantly lower than the base of the unit, a vacuum relief valve may need to be fitted at the highest point in the pipe run in order to avoid siphonage of the water seal.

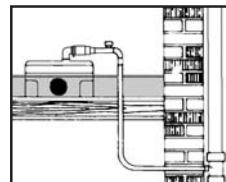

Three Feet Minimum

The macerating unit must be installed at least 3 feet from the soil stack. This will allow the macerator to operate for an adequate period of time to ensure efficient waste reduction.

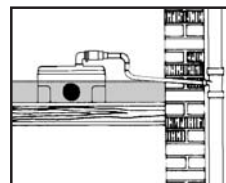

Soil Stack Connection

All discharge pipework must be connected to the soil stack by an appropriate and approved connection. Y pattern fitting as shown is preferable.

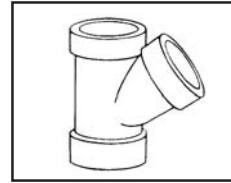

No Diagonal “Uphill” Pipe runs

All discharge pipework from the unit should either run directly upwards from it or in a horizontal plane (with a small gravity flow) to the point of discharge. Pipework should not be installed with diagonal upward slope from the unit to the point of discharge.

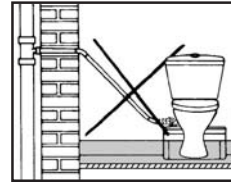

Pipework

All pipework should be either copper or solvent weld plastic. Do not use flexible pipes. Hangers should not be less than four feet apart to prevent pipe rattling.

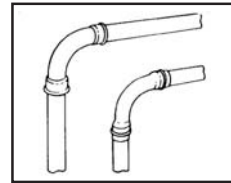

Flushing

The macerating system requires a minimum of 6 litres of water to operate satisfactorily.

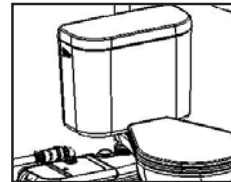

Discharge

Never discharge directly into an open sewer, manhole or rainwater drainpipe. It is illegal as it constitutes a health hazard. Only direct connections into sanitary waste systems are acceptable.

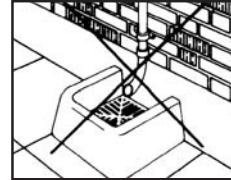

Freezing

Ensure all pipework susceptible to freezing is adequately insulated or heated. In unheated buildings, the toilet, piping and macerating unit must be properly winterized with « recreation vehicle » anti-freeze or drained completely.

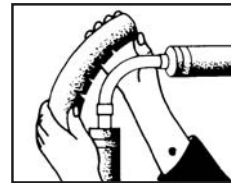

Electricity

Before attempting any maintenance or servicing, the unit must be disconnected from the power source. The macerating system must be connected to a Ground Fault Circuit Interrupter.

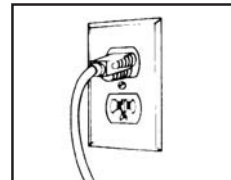

Instructions for qualified professionals only

PROBLEM	CAUSE	REMEDY
Motor turns normally but the water drains slowly from the bowl (incomplete flush).	The discharge tube blocked, fresh-air inlet hole or knife is blocked.	Remove hood and motor mount, clean the tube, the knife and the air inlet.
Waste builds up in the bowl.	Inadequate water supply from tank.	Check and/or increase water level in tank.
The macerating/pump unit does not start up. Water does not drain.	Power supply off. Thermal overload doesn't work. Electronic card is defective.	Wait for thermal overload to engage (approx. 20 min). Change electronic card.
The motor hums but does not turn. The water does not drain.	A foreign object blocks the blade or pump. Defective condenser.	Clean knife and change condensator.
Water goes down slowly and motor works intermittently.	Air inlet is plugged or insufficient VMC connection	Dismantle to clean.
The water drains from the toilet but the motor runs more than 20 seconds and the thermal overload is activated.	Kinked/blocked discharge pipe, defective impeller, partially blocked pump, blocked knife.	Check installation and examine inside the macerating/pump unit.
After drainage the motor engages several times in succession before it stops completely.	Water siphons back into the macerating/pump unit. Non-return valve is not functioning properly.	Flush once or twice with clean water to clear valve or remove valve to clean.
Motor turns noisily without stopping or pumping.	Siphonage or insufficient back pressure in discharge pipe, causing airlock. Foreign object.	Modify discharge pipe run to eliminate siphonage or increase back pressure (e.g. reduce pipe size, put extra bend in run). Remove foreign object.
After water is drained the motor starts, stops, and constantly re-engages.	Water leaking from tank into bowl. Faulty non-return valve.	Check flush valve. Check and clean non-return valve.
The motor turns with a rattling noise.	Solid item has fallen into the Sanigrind and is hitting the knife.	Clear blocked object (see dismantling)
Water backs up into shower or bathtub.	Inadequate gravity-fall into macerating unit.	1/4" to 12" minimum gravity fall between macerating/pump unit and other sanitary fixtures.

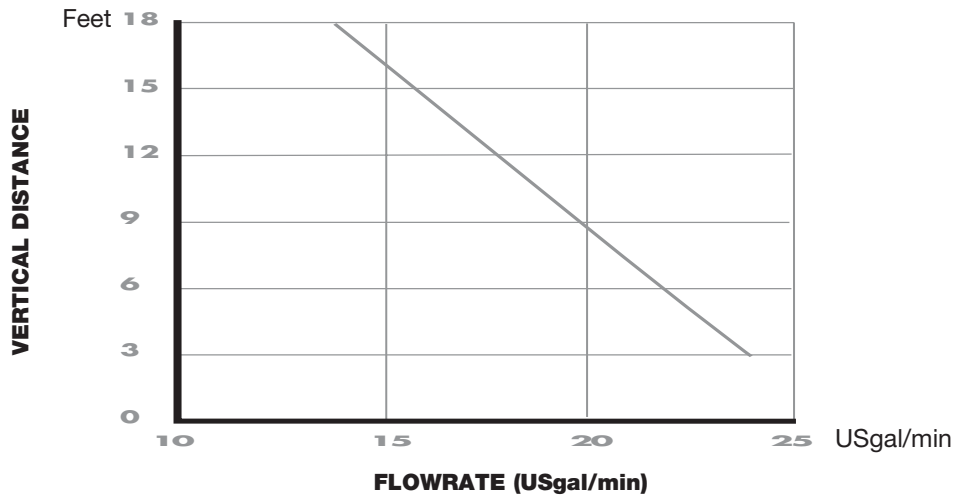

DISTANCE VERTICAL OF 18 FEET, DISTANCE HORIZONTAL OF 150 FEET
(or a lower combination of both)

FLOW 90L/min (24 Gallons/min)

Performance

If you wish the unit to pump vertically and horizontally, you may calculate that three feet of vertical lift is equivalent to 30 feet of horizontal run. Or increase pipe size in the horizontal pipework. For every bend, deduct 3 feet of horizontal distance.

For long distances, the vertical riser should be followed by a horizontal pipe whose diameter should be at least 1 1/2" for drainage by gravity.

When claiming a warranty repair we will need the information you will have written down below. Please ensure that you have all particulars available when requesting warranty work.

Owner's Name: _____

Installation Address: _____

Purchased From: _____

Installed By: _____

Date of Purchase: _____ Serial Number: _____

Date of Manufacture: _____ (see manufacturers' tag on side of unit)

Limited Warranty

Two year Warranty from date of purchase

Subject to the conditions listed below, **SFA SANIFLO INC.** (hereinafter the “Company”) guarantees to repair or at its option replace the product or any component thereof which, in the opinion of the Company, is faulty or below standard as a result of poor workmanship or materials.

The conditions of this guarantee are:

- The Customer must within 7 business days of purchase complete the accompanying warranty card and send it to the Company for registration. Failure to do so may result in denial of warranty claim at the option of the Company.
- The product must have been connected to a single phase 120-volt, 60Hz, electrical supply and not have been subjected to misuse, neglect, accident or exposure to damaging products.
- The product must not have been installed, modified, adjusted or repaired other than by an installer deemed qualified by the company.
- The installer must be notified of the alleged fault or defect or, failing him, the Company, within the warranty period.
- The product is warranted for a two-year period from the date of purchase.
- The product will be exchanged free of charge, at the original re-sellers place of business only, upon the following conditions being fulfilled:
- The customer will need a “Return Authorization (RGA) ” number from the manufacturer to validate the exchange.
- The customer must supply the “bill-of-purchase” to validate the exchange.
- Fill and Flush mechanism as per OEM warranty only.
- No warranty on the vitreous china parts.
- This guarantee does not extend to the cost of disconnection and reconnection of the product.
- In no event shall the company be liable for any special, incidental or consequential damage, loss, or injury of whatsoever nature or kind arising from or in connection with the product or any component thereof.
- This guarantee is transferable only when the unit remains at the same premises as where it was installed initially.
- This guarantee does not extend to the installation of SaniRange products, as the quality of workmanship is beyond our control.
- This guarantee does not extend to the shipping or transport costs when a part or parts of the system has/have to be repaired at the factory.

Except as set forth in this Limited Warranty, the company disclaims all other warranties, express or implied, with respect to the product or any component thereof including, but not limited to, all implied warranties for merchantability and fitness of this product for a particular purpose.

All labour charges, such as a plumber disconnecting or reconnecting the unit, are the end-user’s responsibility.

CANADA

SFA SANIFLO INC.
1-685 Speedvale Ave. West
Guelph, Ontario N1K 1E6
Toll Free: (800) 877 – 8538 French
Toll Free: (800) 363 – 5874 English
Telephone : (519) 824 – 1134
Telefax : (519) 824 – 1143
Email : sfasales@saniflo.com
Website : www.saniflo.com

UNITED STATES

SFA SANIFLO INC.
105 Newfield Avenue, Suite A
Edison, NJ 08837

Toll Free: 800-571-8191
Telephone : 732-225-6070
Telefax : 732-225-6072
Email : sfasales@saniflo.com
Website : www.saniflo.com

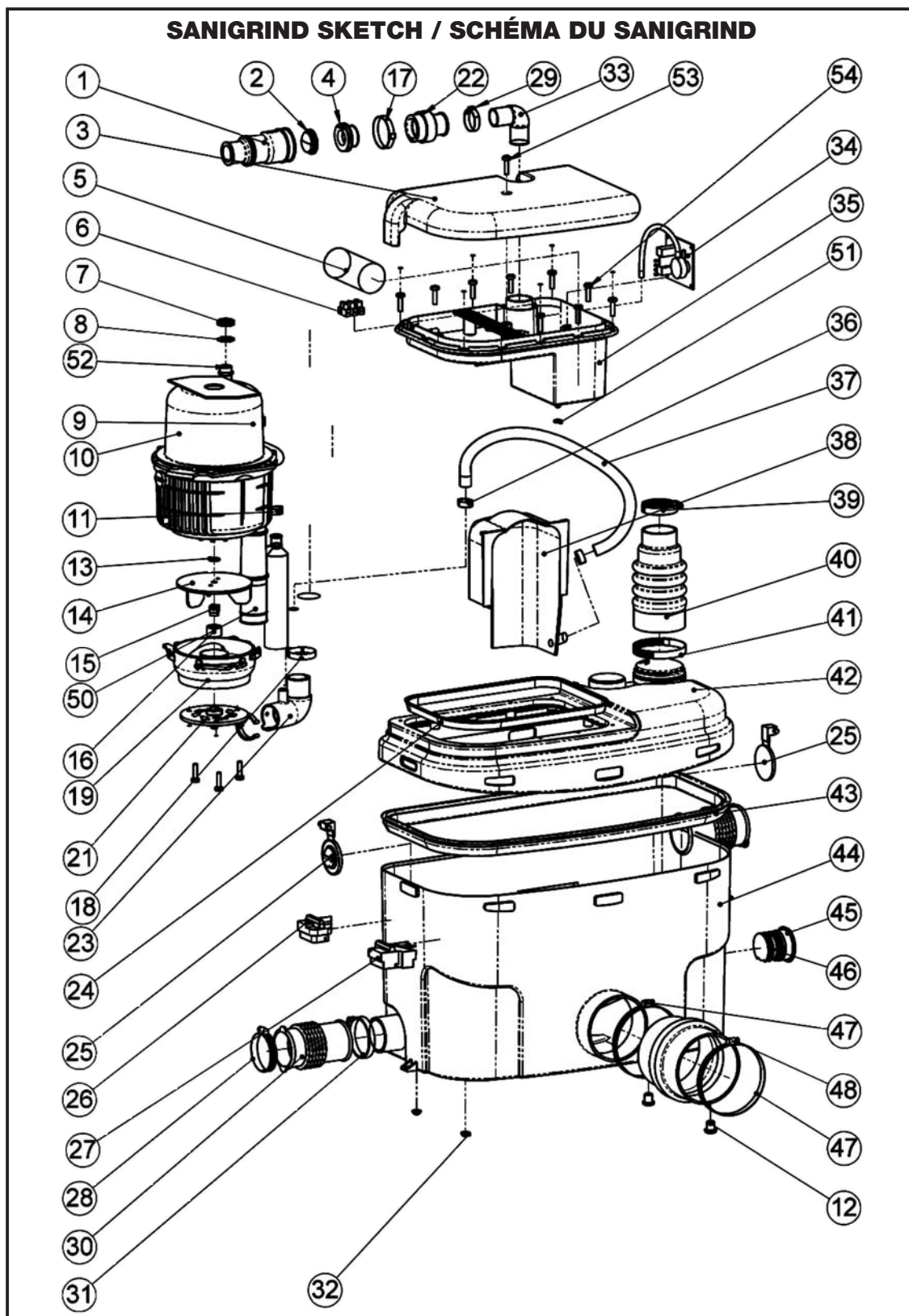

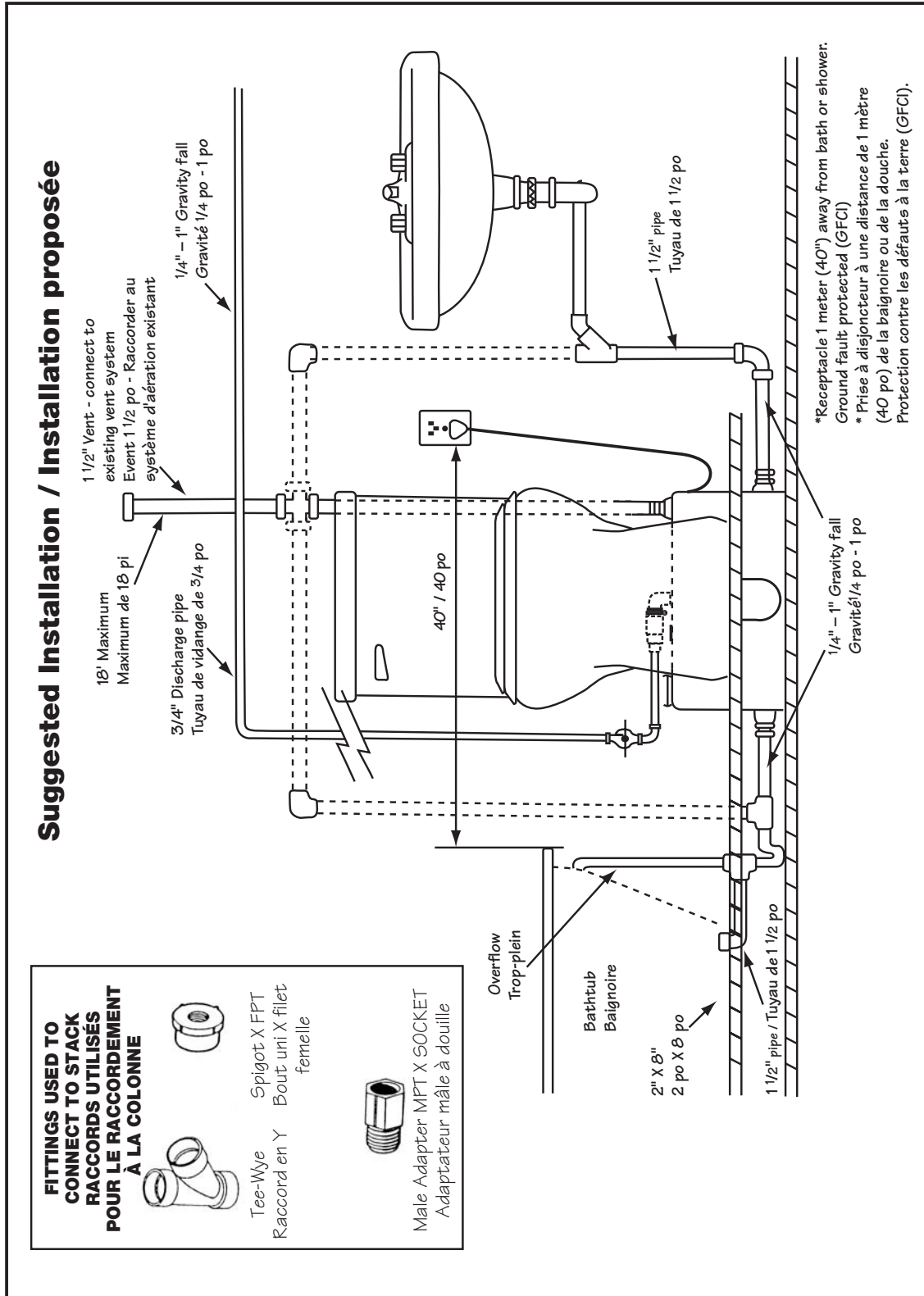

Unit Dimensions / Dimensions de l'appareil

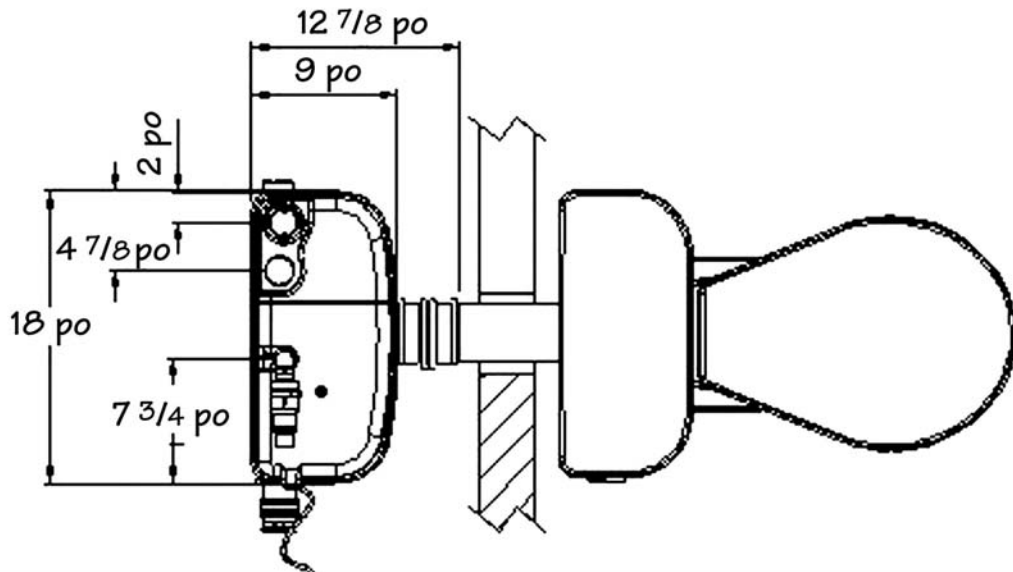

Connection to bowl / Raccordement à la cuvette

